



# TDA7564

## MULTIFUNCTION QUAD POWER AMPLIFIER WITH BUILT-IN DIAGNOSTICS FEATURES

- DMOS POWER OUTPUT
- NON-SWITCHING HI-EFFICIENCY
- HIGH OUTPUT POWER CAPABILITY 4x28W/4Ω @ 14.4V, 1KHZ, 10% THD, 4x40W EIAJ
- MAX. OUTPUT POWER 4x72W/2Ω
- FULL I<sup>2</sup>C BUS DRIVING:
  - ST-BY
  - INDEPENDENT FRONT/REAR SOFT PLAY/ MUTE
  - SELECTABLE GAIN 26dB - 12dB (FOR LOW NOISE LINE OUTPUT FUNCTION)
  - HIGH EFFICIENCY ENABLE/DISABLE
  - I<sup>2</sup>C BUS DIGITAL DIAGNOSTICS
- FULL FAULT PROTECTION
- DC OFFSET DETECTION
- FOUR INDEPENDENT SHORT CIRCUIT PROTECTION
- CLIPPING DETECTOR (2% - 10%) PROTECTION

### DESCRIPTION

The TDA7564 is a new BCD technology QUAD BRIDGE type of car radio amplifier in Flexiwatt25 package specially intended for car radio applica-

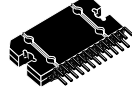
<b>MULTIPOWER BCD TECHNOLOGY</b>
<b>MOSFET OUTPUT POWER STAGE</b>
 <b>FLEXIWATT25</b> <b>ORDERING NUMBER: TDA7564</b>

tions. Thanks to the DMOS output stage the TDA7564 has a very low distortion allowing a clear powerful sound. Among the features, its superior efficiency performance coming from the internal exclusive structure, makes it the most suitable device to simplify the thermal management in high power sets. The dissipated output power under average listening condition is in fact reduced up to 50% when compared to the level provided by conventional class AB solutions. This device is equipped with a full diagnostics array that communicates the status of each speaker through the I<sup>2</sup>C bus. The possibility to control the configuration and behaviour of the device by means of the I<sup>2</sup>C bus makes TDA7564 a very flexible machine.

### BLOCK DIAGRAM

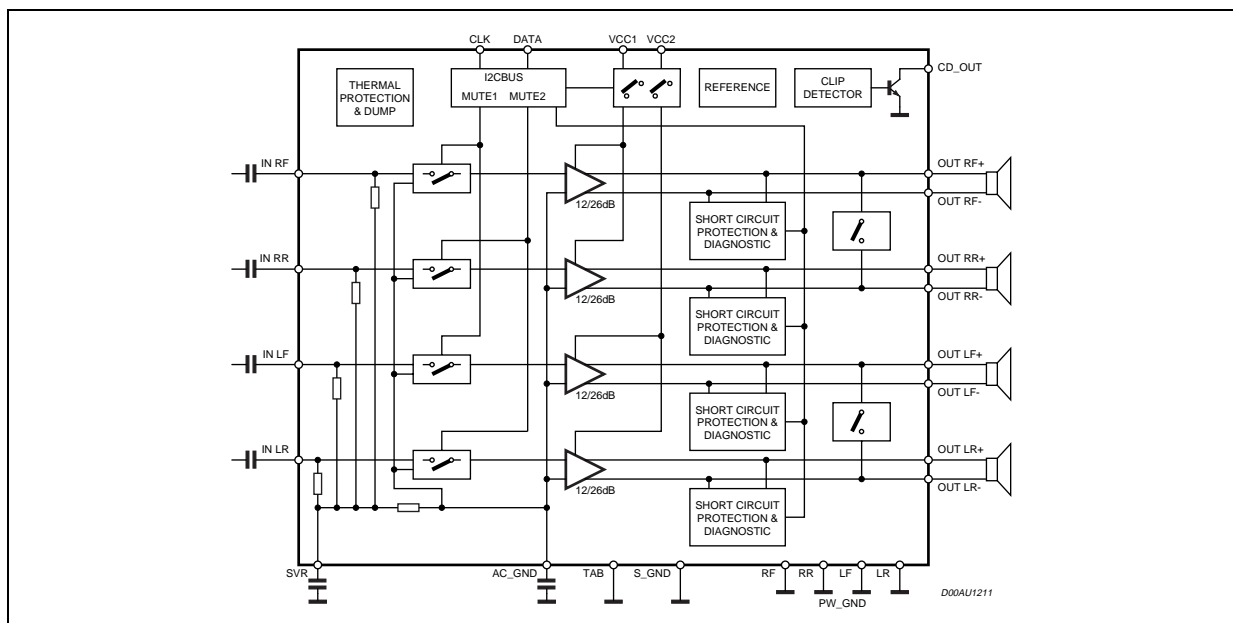

# TDA7564

## ABSOLUTE MAXIMUM RATINGS

Symbol	Parameter	Value	Unit
$V_{op}$	Operating Supply Voltage	18	V
$V_S$	DC Supply Voltage	28	V
$V_{peak}$	Peak Supply Voltage (for $t = 50ms$ )	50	V
$V_{CK}$	CK pin Voltage	6	V
$V_{DATA}$	Data Pin Voltage	6	V
$I_O$	Output Peak Current (not repetitive $t = 100ms$ )	8	A
$I_O$	Output Peak Current (repetitive $f > 10Hz$ )	6	A
$P_{tot}$	Power Dissipation $T_{case} = 70^{\circ}C$	85	W
$T_{stg}, T_j$	Storage and Junction Temperature	-55 to 150	$^{\circ}C$

## THERMAL DATA

Symbol	Parameter	Value	Unit
$R_{th\ j-case}$	Thermal Resistance Junction to case	Max. 1	$^{\circ}C/W$

## PIN CONNECTION (Top view)

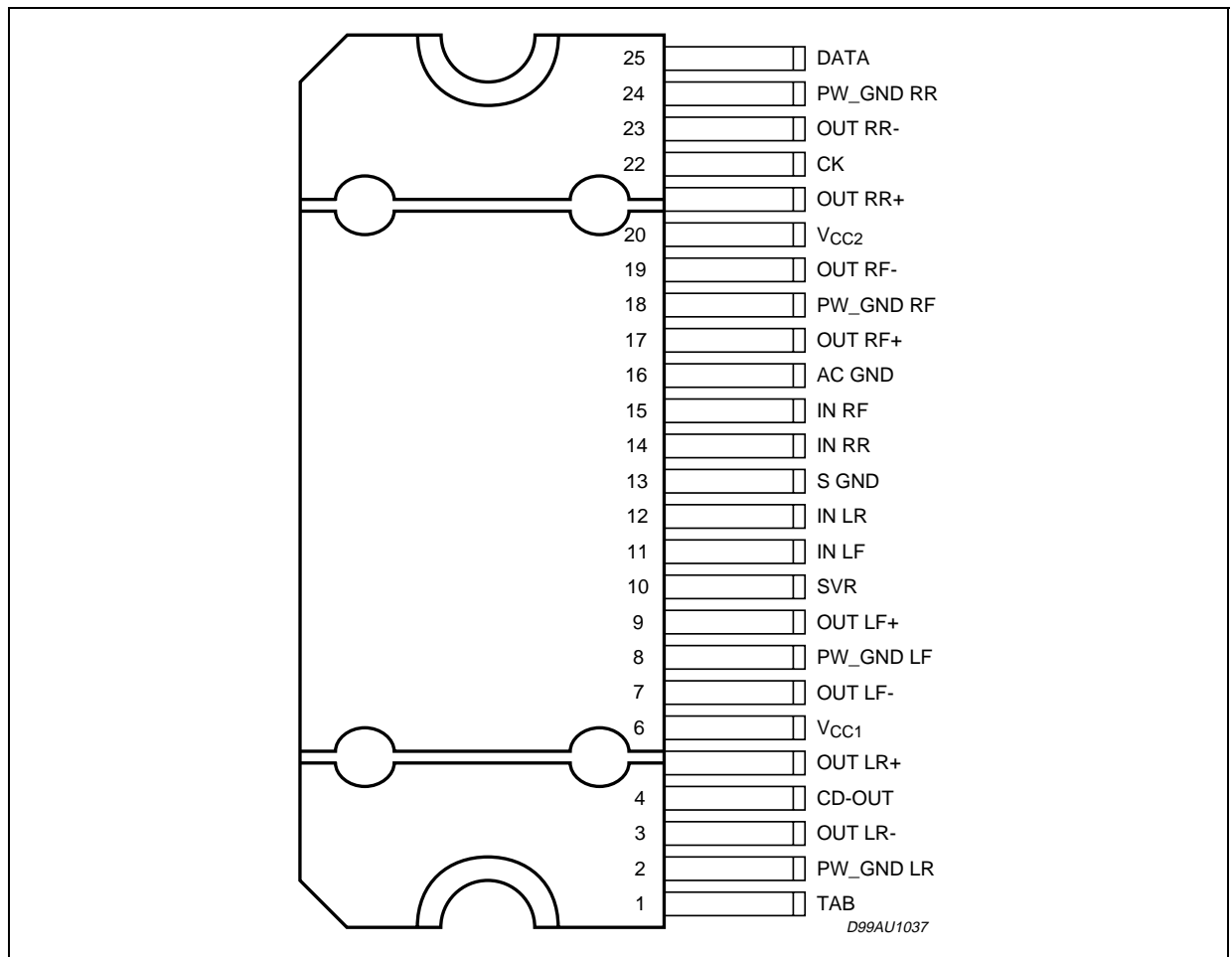
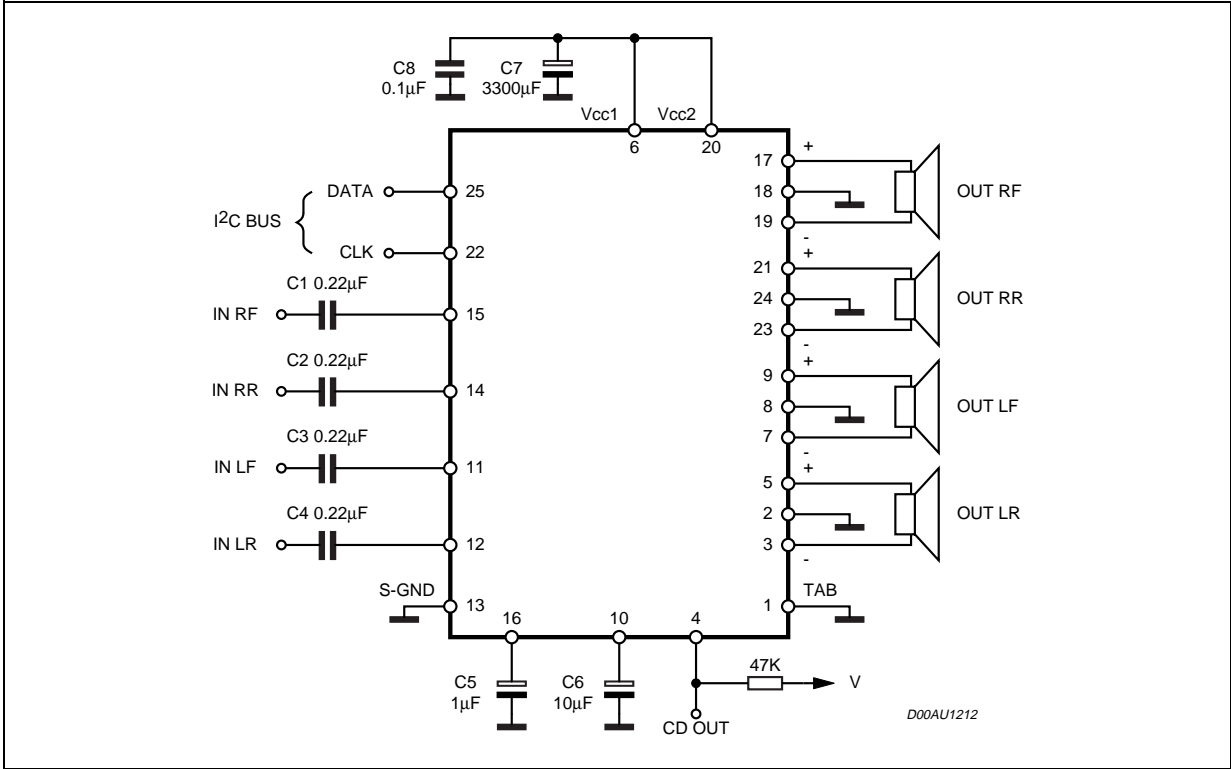

Figure 1. Application Circuit



**ELECTRICAL CHARACTERISTICS**

(Refer to the test circuit,  $V_S = 14.4V$ ;  $R_L = 4\Omega$ ;  $f = 1KHz$ ;  $T_{amb} = 25^\circ C$ ; unless otherwise specified.)

Symbol	Parameter	Test Condition	Min.	Typ.	Max.	Unit
<b>POWER AMPLIFIER</b>						
$V_S$	Supply Voltage Range		8		18	V
$I_d$	Total Quiescent Drain Current			170	300	mA
$P_O$	Output Power	EIAJ ( $V_S = 13.7V$ )	35	40		W
		THD = 10%	25	28		W
		THD = 1%		22		W
		$R_L = 2\Omega$ ; EIAJ ( $V_S = 13.7V$ )	55	62		W
		$R_L = 2\Omega$ ; THD 10%	40	46		W
	$R_L = 2\Omega$ ; THD 1%		35		W	
	$R_L = 2\Omega$ ; MAX POWER		72		W	
THD	Total Harmonic Distortion	$P_O = 1W$ to $10W$ ; STD MODE		0.02	0.1	%
		HE MODE; $P_O = 1.5W$		0.015	0.1	%
		HE MODE; $P_O = 8W$		0.15	0.5	%
		$G_V = 12dB$ ; STD Mode		0.02	0.05	%
		$V_O = 0.1$ to $5VRMS$				
$C_T$	Cross Talk	$f = 1KHz$ to $10KHz$ , $R_g = 600\Omega$	50	60		dB
$R_{IN}$	Input Impedance		60	100	130	K $\Omega$
$G_{V1}$	Voltage Gain 1		25	26	27	dB
$\Delta G_{V1}$	Voltage Gain Match 1		-1		1	dB
$G_{V2}$	Voltage Gain 2		11	12	13	dB
$\Delta G_{V2}$	Voltage Gain Match 2		-1		1	dB
$E_{IN1}$	Output Noise Voltage 1	$R_g = 600\Omega$ , $20Hz$ to $22kHz$		35	100	$\mu V$
$E_{IN2}$	Output Noise Voltage 2	$R_g = 600\Omega$ ; $G_V = 12dB$ $20Hz$ to $22kHz$		12	30	$\mu V$
SVR	Supply Voltage Rejection	$f = 100Hz$ to $10kHz$ ; $V_r = 1Vpk$ ; $R_g = 600\Omega$	50	60		dB
BW	Power Bandwidth		100			KHz
$A_{SB}$	Stand-by Attenuation		90	110		dB
$I_{SB}$	Stand-by Current Consumption			25	100	$\mu A$
$A_M$	Mute Attenuation		80	100		dB
$V_{OS}$	Offset Voltage	Mute & Play	-100	0	100	mV
$T_{ON}$	Turn ON Delay	D2/D1 (IB1) 0 to 1		20	40	ms
$T_{OFF}$	Turn OFF Delay	D2/D1 (IB1) 1 to 0		20	40	ms
$V_{AM}$	Min. Supply Mute Threshold		7	7.5	8	V
$CD_{LK}$	Clip Det High Leakage Current	CD off		0	15	$\mu A$
$CD_{SAT}$	Clip Det Sat. Voltage	CD on; $I_{CD} = 1mA$		150	300	mV
$CD_{THD}$	Clip Det THD level	D0 (IB1) = 0	1	2	3	%
		D0 (IB1) = 1	5	10	15	%
<b>TURN ON DIAGNOSTICS 1 (Power Amplifier Mode)</b>						
Pgnd	Short to GND det. (below this limit, the Output is considered in Short Circuit to GND)	Power Amplifier in st-by			1.2	V
Pvs	Short to Vs det. (above this limit, the Output is considered in Short Circuit to Vs)		$V_S - 1.2$			V

**ELECTRICAL CHARACTERISTICS** (continued)(Refer to the test circuit,  $V_S = 14.4V$ ;  $R_L = 4\Omega$ ;  $f = 1KHz$ ;  $T_{amb} = 25^\circ C$ ; unless otherwise specified.)

Symbol	Parameter	Test Condition	Min.	Typ.	Max.	Unit
Pnop	Normal operation thresholds. (Within these limits, the Output is considered without faults).	Power Amplifier in st-by	1.8		$V_S - 1.8$	V
Lsc	Shorted Load det.				0.5	$\Omega$
Lop	Open Load det.		85			$\Omega$
Lnop	Normal Load det.		1.75		45	$\Omega$
<b>TURN ON DIAGNOSTICS 2 (Line Driver Mode)</b>						
Pgnd	Short to GND det. (below this limit, the Output is considered in Short Circuit to GND)	Power Amplifier in st-by			1.2	V
Pvs	Short to $V_S$ det. (above this limit, the Output is considered in Short Circuit to $V_S$ )		$V_S - 1.2$			V
Pnop	Normal operation thresholds. (Within these limits, the Output is considered without faults).		1.8		$V_S - 1.8$	V
Lsc	Shorted Load det.				2	$\Omega$
Lop	Open Load det.		330			$\Omega$
Lnop	Normal Load det.		7		180	$\Omega$
<b>PERMANENT DIAGNOSTICS 2 (Power Amplifier Mode or Line Driver Mode)</b>						
Pgnd	Short to GND det. (below this limit, the Output is considered in Short Circuit to GND)	Power Amplifier in Mute or Play, one or more short circuits protection activated			1.2	V
Pvs	Short to $V_S$ det. (above this limit, the Output is considered in Short Circuit to $V_S$ )		$V_S - 1.2$			V
Pnop	Normal operation thresholds. (Within these limits, the Output is considered without faults).		1.8		$V_S - 1.8$	V
L <sub>SC</sub>	Shorted Load Det.	Pow. Amp. mode			0.5	$\Omega$
		Line Driver mode			2	$\Omega$
V <sub>O</sub>	Offset Detection	Power Amplifier in play, AC Input signals = 0	$\pm 1.5$	$\pm 2$	$\pm 2.5$	V
I <sub>NL</sub>	Normal load current detection	$V_O < (V_S - 5)pk$			500	mA
I <sub>OL</sub>	Open load current detection	$V_O < (V_S - 5)pk$			250	mA
<b>I<sup>2</sup>C BUS INTERFACE</b>						
f <sub>SCL</sub>	Clock Frequency			400		KHz
V <sub>IL</sub>	Input Low Voltage				1.5	V
V <sub>IH</sub>	Input High Voltage		2.3			V

Figure 2. Quiescent Current vs. Supply Voltage

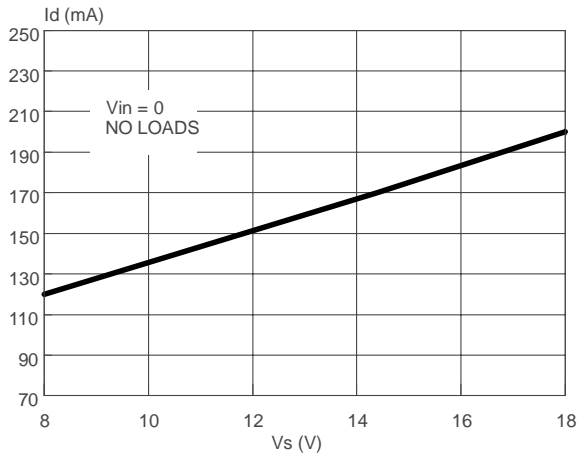

Figure 5. Distortion vs. Output Power (4Ω, STD)

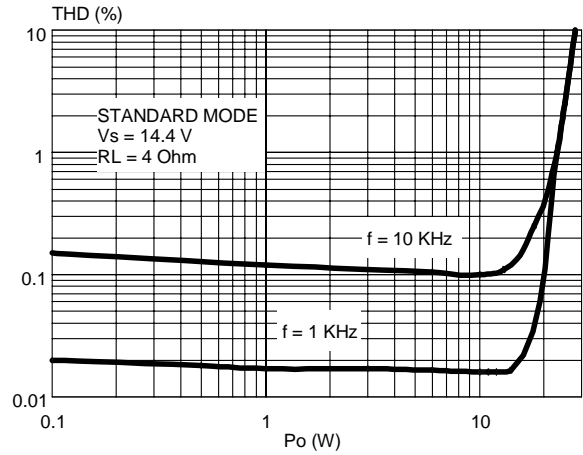

Figure 3. Output Power vs. Supply Voltage (4Ω)

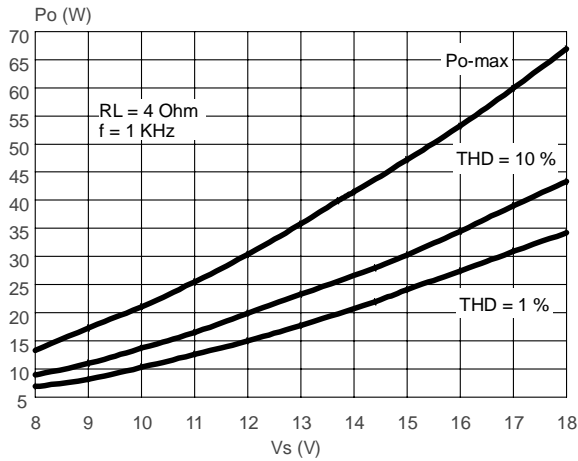

Figure 6. Distortion vs. Output Power (4Ω, HI-EFF)

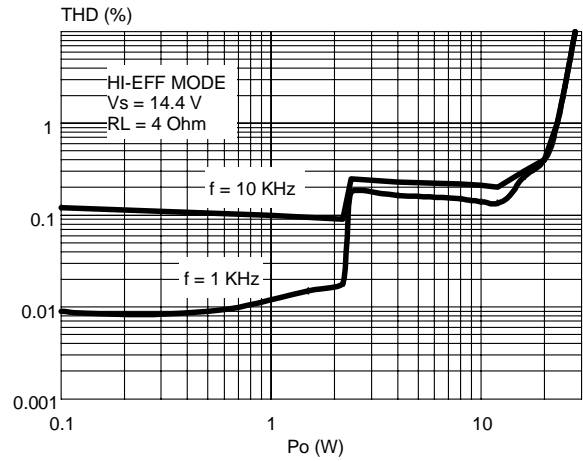

Figure 4. Output Power vs. Supply Voltage (2Ω)

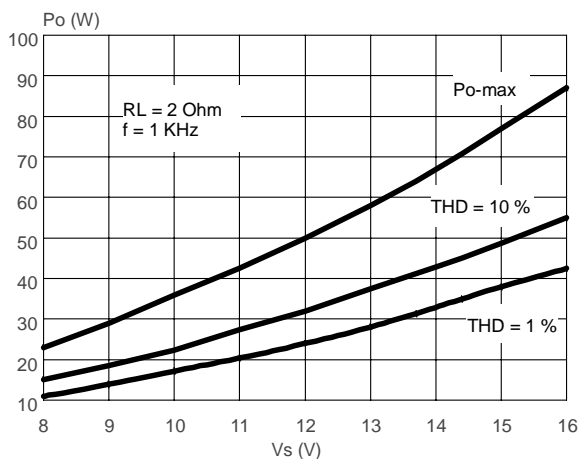

Figure 7. Distortion vs. Output Power (2Ω, STD)

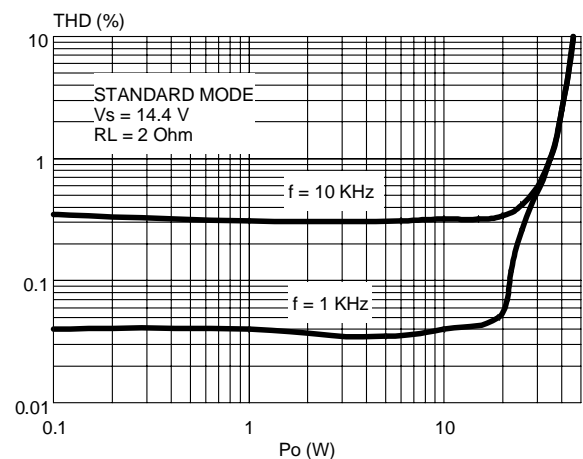

Figure 8. Distortion vs. Frequency (4Ω)

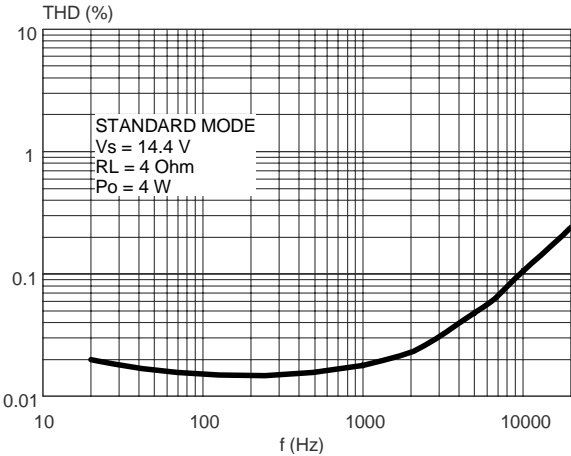

Figure 11. Supply Voltage Rejection vs. Freq.

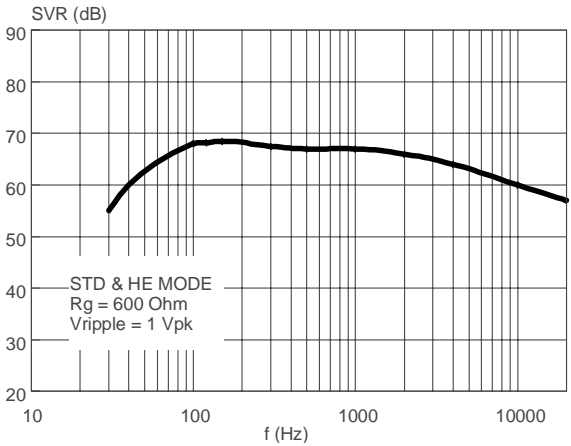

Figure 9. Distortion vs. Frequency (2Ω)

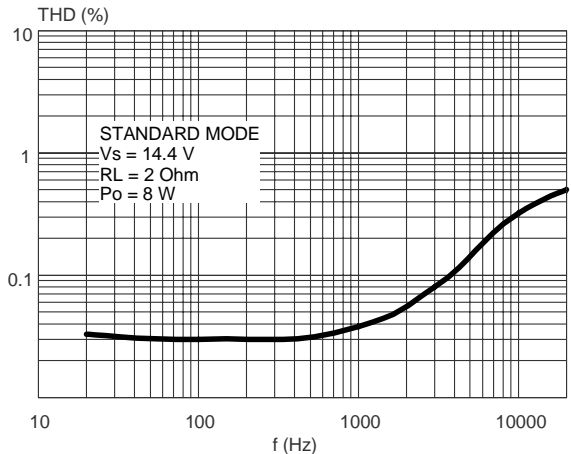

Figure 12. Power Dissipation & Efficiency vs. Output Power (4Ω, STD, SINE)

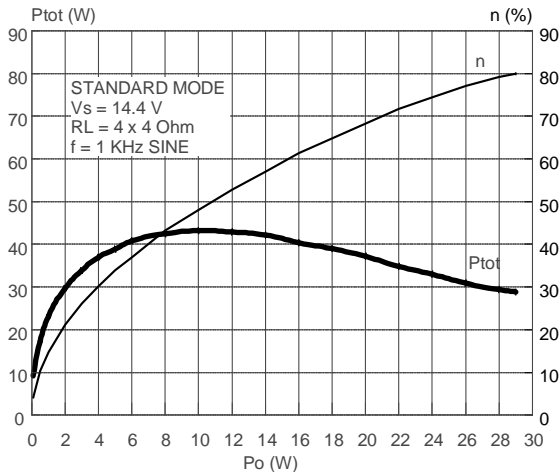

Figure 10. Crosstalk vs. Frequency

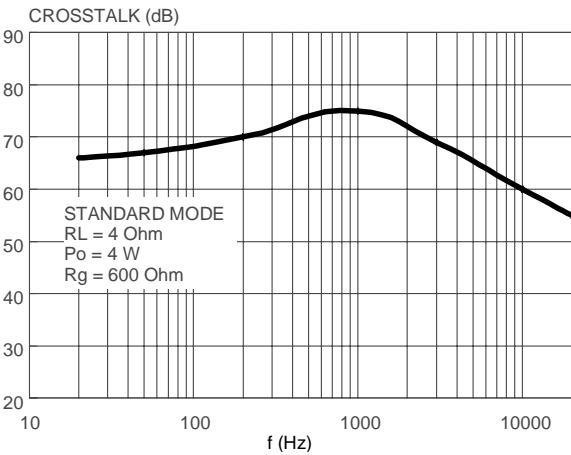
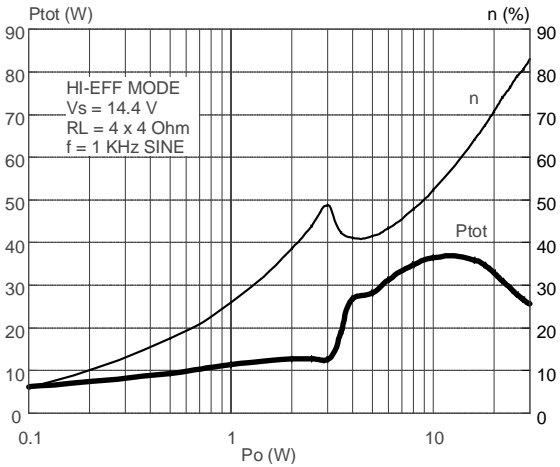
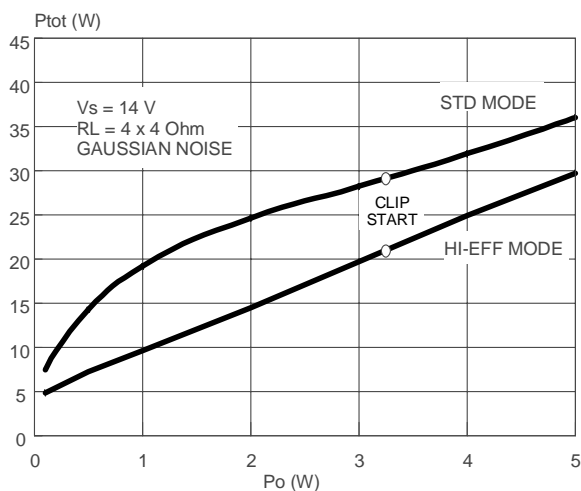

Figure 13. Power Dissipation & Efficiency vs. Output Power (4W, HI-EFF, SINE)



**Figure 14. Power Dissipation vs. Average Output Power (Audio Program Simulation, 4Ω)**



**Figure 15. Power Dissipation vs. Average Output Power (Audio Program Simulation, 2Ω)**

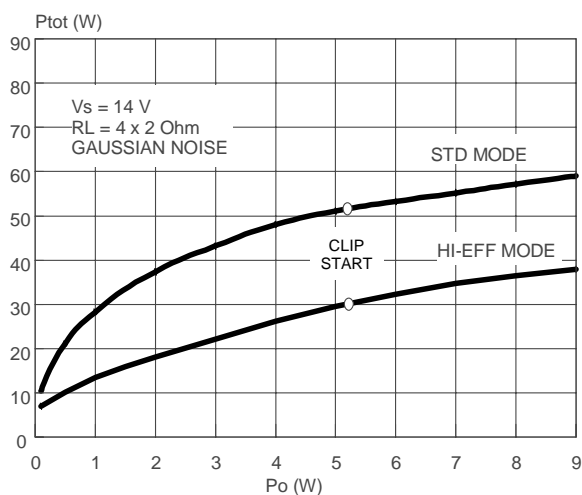

**DIAGNOSTICS FUNCTIONAL DESCRIPTION:**

**a) TURN-ON DIAGNOSTIC**

It is activated at the turn-on (stand-by out) under I<sup>2</sup>Cbus request. Detectable output faults are:

- SHORT TO GND
- SHORT TO Vs
- SHORT ACROSS THE SPEAKER
- OPEN SPEAKER

To verify if any of the above misconnections are in place, a subsonic (inaudible) current pulse (fig. 16) is internally generated, sent through the speaker(s) and sunk back. The Turn On diagnostic status is internally stored until a successive diagnostic pulse is requested (after a I2C reading).

If the "stand-by out" and "diag. enable" commands are both given through a single programming step, the pulse takes place first (power stage still in stand-by mode, low, outputs= high impedance).

Afterwards, when the Amplifier is biased, the PERMANENT diagnostic takes place. The previous Turn On state is kept until a short appears at the outputs.

**Figure 16. Turn - On diagnostic: working principle**

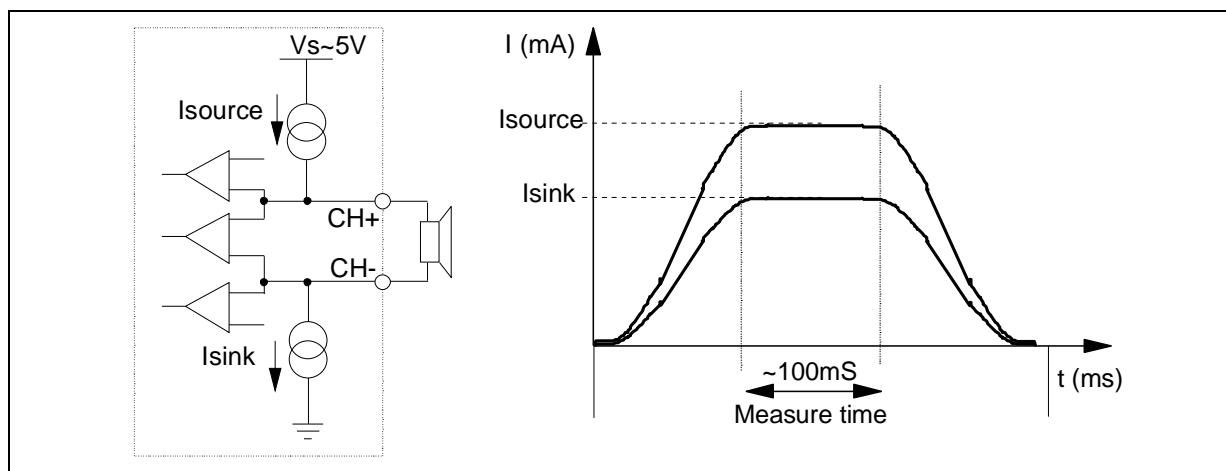



Fig. 17 and 18 show SVR and OUTPUT waveforms at the turn-on (stand-by out) with and without TURN-ON DIAGNOSTIC.

Figure 17. SVR and Output behaviour (CASE 1: without turn-on diagnostic)

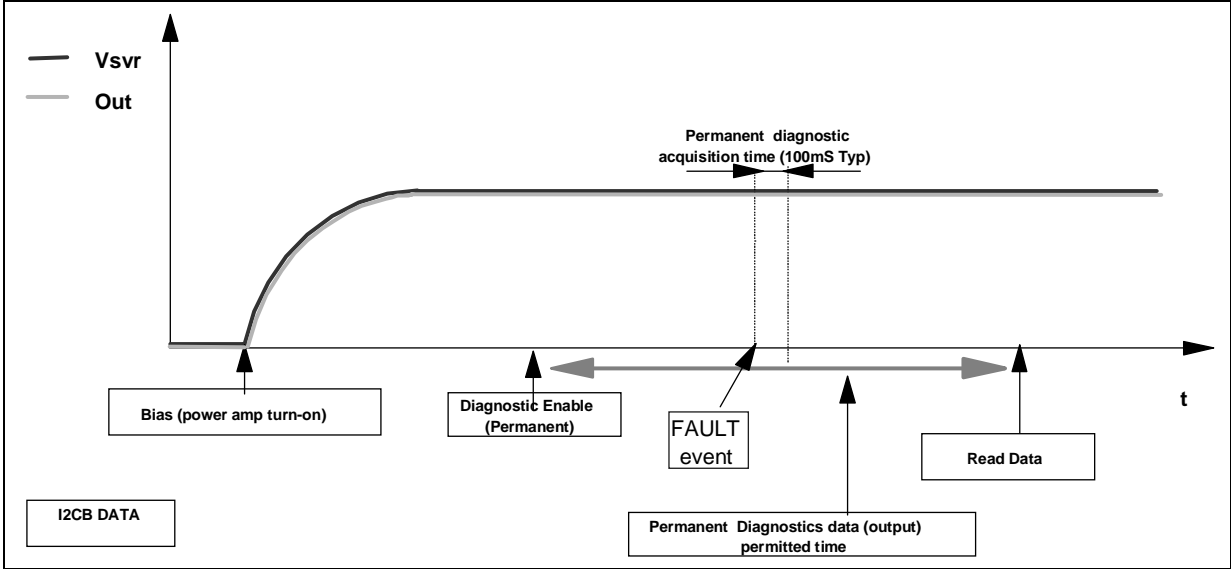
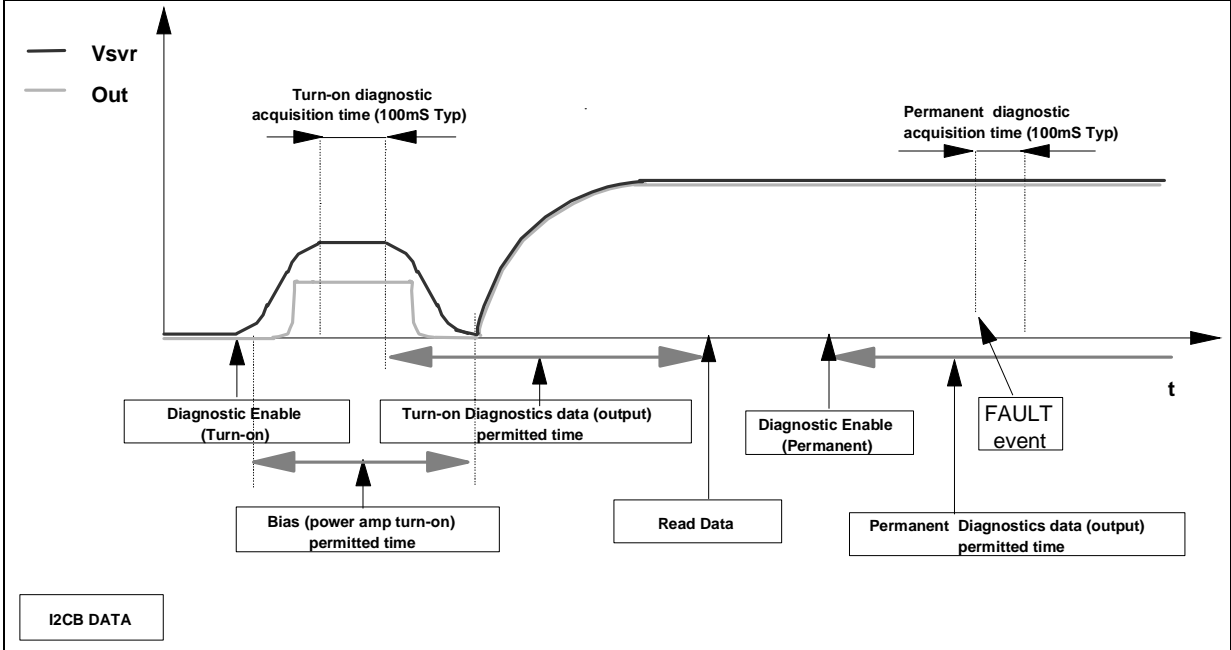
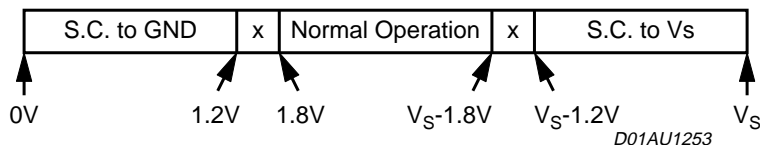

Figure 18. SVR and Output pin behaviour (CASE 2: with turn-on diagnostic)



The information related to the outputs status is read and memorized at the end of the current pulse top. The acquisition time is 100 ms (typ.). No audible noise is generated in the process. As for SHORT TO GND / Vs the fault-detection thresholds remain unchanged from 26 dB to 12 dB gain setting. They are as follows:



Concerning SHORT ACROSS THE SPEAKER / OPEN SPEAKER, the threshold varies from 26 dB to 12 dB gain setting, since different loads are expected (either normal speaker's impedance or high impedance). The values in case of 26 dB gain are as follows:

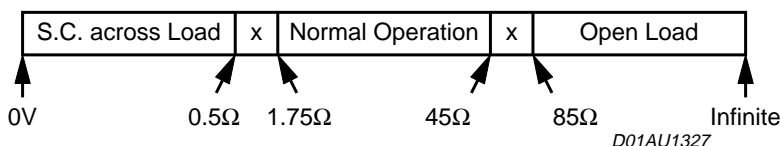

If the Line-Driver mode ( $G_v = 12$  dB and Line Driver Mode diagnostic = 1) is selected, the same thresholds will change as follows:

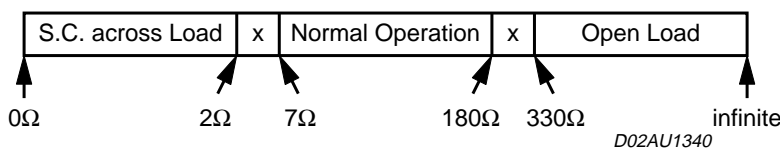

**b) PERMANENT DIAGNOSTICS.**

Detectable conventional faults are:

- SHORT TO GND
- SHORT TO Vs
- SHORT ACROSS THE SPEAKER

The following additional features are provided:

- OUTPUT OFFSET DETECTION

The TDA7564 has 2 operating statuses:

- 1 RESTART mode. The diagnostic is not enabled. Each audio channel operates independently from each other. If any of the a.m. faults occurs, only the channel(s) interested is shut down. A check of the output status is made every 1 ms (fig. 19). Restart takes place when the overload is removed.
- 2 DIAGNOSTIC mode. It is enabled via I<sup>2</sup>C bus and self activates if an output overload (such to cause the intervention of the short-circuit protection) occurs to the speakers outputs. Once activated, the diagnostics procedure develops as follows (fig. 20):
  - To avoid momentary re-circulation spikes from giving erroneous diagnostics, a check of the output status is made after 1ms: if normal situation (no overloads) is detected, the diagnostic is not performed and the channel returns back active.
  - Instead, if an overload is detected during the check after 1 ms, then a diagnostic cycle having a duration of about 100 ms is started.

- After a diagnostic cycle, the audio channel interested by the fault is switched to RESTART mode. The relevant data are stored inside the device and can be read by the microprocessor. When one cycle has terminated, the next one is activated by an I<sup>2</sup>C reading. This is to ensure continuous diagnostics throughout the car-radio operating time.
- To check the status of the device a sampling system is needed. The timing is chosen at microprocessor level (over half a second is recommended).

**Figure 19. Restart timing without Diagnostic Enable (Permanent) - Each 1mS time, a sampling of the fault is done**

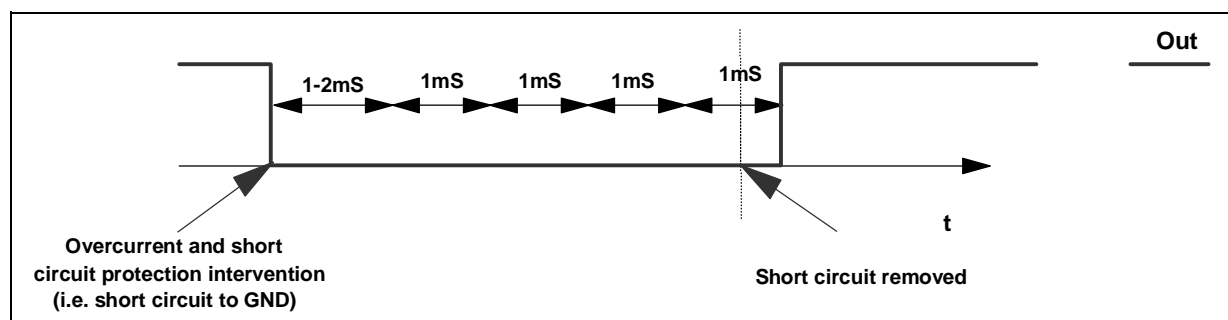

**Figure 20. Restart timing with Diagnostic Enable (Permanent)**

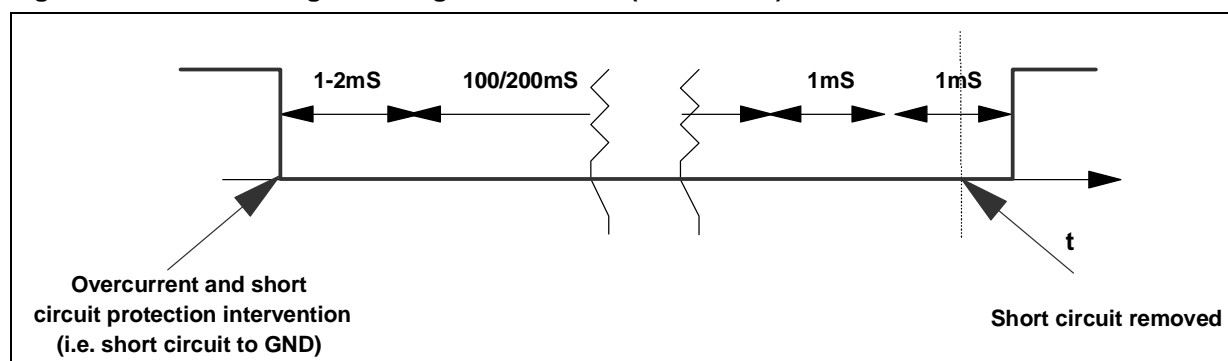

### OUTPUT DC OFFSET DETECTION

Any DC output offset exceeding  $\pm 2V$  are signalled out. This inconvenient might occur as a consequence of initially defective or aged and worn-out input capacitors feeding a DC component to the inputs, so putting the speakers at risk of overheating.

This diagnostic has to be performed with low-level output AC signal (or  $V_{in} = 0$ ).

The test is run with selectable time duration by microprocessor (from a "start" to a "stop" command):

- START = Last reading operation or setting IB1 - D5 - (OFFSET enable) to 1
- STOP = Actual reading operation

Excess offset is signalled out if persistent throughout the assigned testing time. This feature is disabled if any overloads leading to activation of the short-circuit protection occurs in the process.

### AC DIAGNOSTIC.

It is targeted at detecting accidental disconnection of tweeters in 2-way speaker and, more in general, presence of capacitively (AC) coupled loads.

This diagnostic is based on the notion that the overall speaker's impedance (woofer + parallel tweeter) will tend to increase towards high frequencies if the tweeter gets disconnected, because the remaining speaker (woofer) would be out of its operating range (high impedance). The diagnostic decision is made according to peak output

current thresholds, as follows:

$I_{out} > 500\text{mA}_{pk} = \text{NORMAL STATUS}$

$I_{out} < 250\text{mA}_{pk} = \text{OPEN TWEETER}$

To correctly implement this feature, it is necessary to briefly provide a signal tone (with the amplifier in "play") whose frequency and magnitude are such to determine an output current higher than 500mA<sub>pk</sub> in normal conditions and lower than 250mA<sub>pk</sub> should the parallel tweeter be missing. The test has to last for a minimum number of 3 sine cycles starting from the activation of the AC diagnostic function IB2<D2> up to the I2C reading of the results (measuring period). To confirm presence of tweeter, it is necessary to find at least 3 current pulses over 500mA over all the measuring period, else an "open tweeter" message will be issued.

The frequency / magnitude setting of the test tone depends on the impedance characteristics of each specific speaker being used, with or without the tweeter connected (to be calculated case by case). High-frequency tones (> 10 KHz) or even ultrasonic signals are recommended for their negligible acoustic impact and also to maximize the impedance module's ratio between with tweeter-on and tweeter-off.

Fig. 21 shows the Load Impedance as a function of the peak output voltage and the relevant diagnostic fields. This feature is disabled if any overloads leading to activation of the short-circuit protection occurs in the process.

**Figure 21. Current detection: Load impedance magnitude |Z| vs. output peak voltage of the sinus**

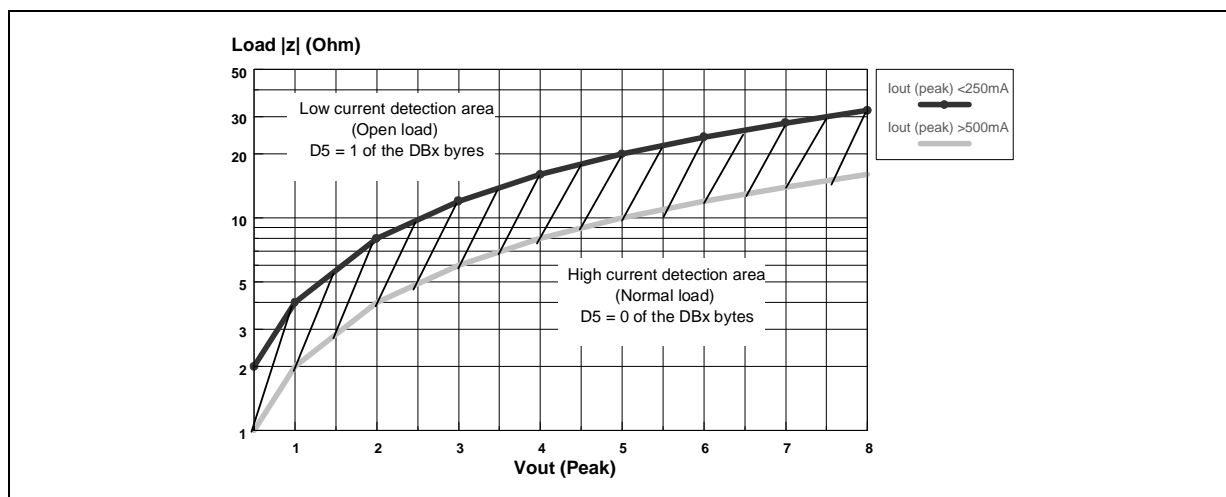

**MULTIPLE FAULTS**

When more misconnections are simultaneously in place at the audio outputs, it is guaranteed that at least one of them is initially read out. The others are notified after successive cycles of I<sup>2</sup>C reading and faults removal, provided that the diagnostic is enabled. This is true for both kinds of diagnostic (Turn on and Permanent).

The table below shows all the couples of double-fault possible. It should be taken into account that a short circuit with the 4 ohm speaker unconnected is considered as double fault.

Double fault table for Turn On Diagnostic					
	S. GND (so)	S. GND (sk)	S. Vs	S. Across L.	Open L.
S. GND (so)	S. GND	S. GND	S. Vs + S. GND	S. GND	S. GND
S. GND (sk)	/	S. GND	S. Vs	S. GND	Open L. (*)
S. Vs	/	/	S. Vs	S. Vs	S. Vs
S. Across L.	/	/	/	S. Across L.	N.A.
Open L.	/	/	/	/	Open L. (*)

S. GND (so) / S. GND (sk) in the above table make a distinction according to which of the 2 outputs is shorted to ground (test-current source side= so, test-current sink side = sk). More precisely, in Channels LF and RR, so = CH+, sk = CH-; in Channels LR and RF, so = CH-, sk = CH+ .

In Permanent Diagnostic the table is the same, with only a difference concerning Open Load(\*) , which is not among the recognisable faults. Should an Open Load be present during the device's normal working, it would be detected at a subsequent Turn on Diagnostic cycle (i.e. at the successive Car Radio Turn on).

### FAULTS AVAILABILITY

All the results coming from I<sup>2</sup>C bus, by read operations, are the consequence of measurements inside a defined period of time. If the fault is stable throughout the whole period, it will be sent out. This is true for DC diagnostic (Turn on and Permanent), for Offset Detector, for AC Diagnostic (the low current sensor needs to be stable to confirm the Open tweeter).

To guarantee always resident functions, every kind of diagnostic cycles (Turn on, Permanent, Offset, AC) will be reactivate after any I<sup>2</sup>C reading operation. So, when the micro reads the I<sup>2</sup>C, a new cycle will be able to start, but the read data will come from the previous diag. cycle (i.e. The device is in Turn On state, with a short to Gnd, then the short is removed and micro reads I<sup>2</sup>C. The short to Gnd is still present in bytes, because it is the result of the previous cycle. If another I<sup>2</sup>C reading operation occurs, the bytes do not show the short). In general to observe a change in Diagnostic bytes, two I<sup>2</sup>C reading operations are necessary.

### I<sup>2</sup>C PROGRAMMING/READING SEQUENCES

A correct turn on/off sequence respectful of the diagnostic timings and producing no audible noises could be as follows (after battery connection):

TURN-ON: (STAND-BY OUT + DIAG ENABLE) --- 500 ms (min) --- MUTING OUT

TURN-OFF: MUTING IN --- 20 ms --- (DIAG DISABLE + STAND-BY IN)

Car Radio Installation: DIAG ENABLE (write) --- 200 ms --- I<sup>2</sup>C read (repeat until All faults disappear).

AC TEST: FEED H.F. TONE -- AC DIAG ENABLE (write) --- WAIT > 3 CYCLES --- I<sup>2</sup>C read (repeat I<sup>2</sup>C reading until tweeter-off message disappears).

OFFSET TEST: Device in Play (no signal) -- OFFSET ENABLE - 30ms - I<sup>2</sup>C reading (repeat I<sup>2</sup>C reading until high-offset message disappears).

**I<sup>2</sup>C BUS INTERFACE**

Data transmission from microprocessor to the TDA7564 and viceversa takes place through the 2 wires I<sup>2</sup>C BUS interface, consisting of the two lines SDA and SCL (pull-up resistors to positive supply voltage must be connected).

**Data Validity**

As shown by fig. 22, the data on the SDA line must be stable during the high period of the clock. The HIGH and LOW state of the data line can only change when the clock signal on the SCL line is LOW.

**Start and Stop Conditions**

As shown by fig. 23 a start condition is a HIGH to LOW transition of the SDA line while SCL is HIGH. The stop condition is a LOW to HIGH transition of the SDA line while SCL is HIGH.

**Byte Format**

Every byte transferred to the SDA line must contain 8 bits. Each byte must be followed by an acknowledge bit. The MSB is transferred first.

**Acknowledge**

The transmitter\* puts a resistive HIGH level on the SDA line during the acknowledge clock pulse (see fig. 24). The receiver\*\* the acknowledges has to pull-down (LOW) the SDA line during the acknowledge clock pulse, so that the SDA line is stable LOW during this clock pulse.

\* Transmitter

- = master (μP) when it writes an address to the TDA7564
- = slave (TDA7564) when the μP reads a data byte from TDA7564

\*\* Receiver

- = slave (TDA7564) when the μP writes an address to the TDA7564
- = master (μP) when it reads a data byte from TDA7564

**Figure 22. Data Validity on the I<sup>2</sup>C BUS**

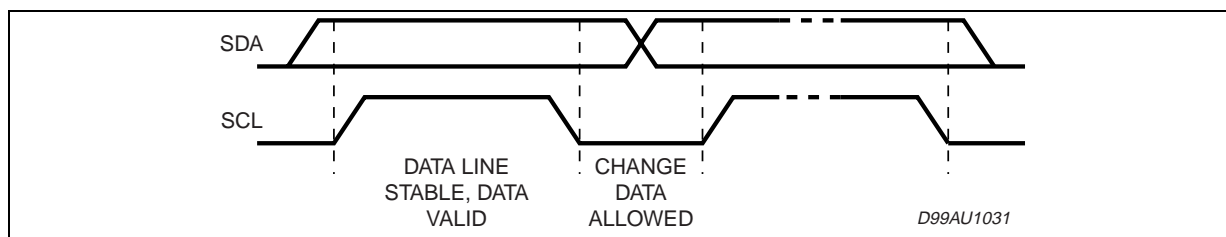

**Figure 23. Timing Diagram on the I<sup>2</sup>C BUS**

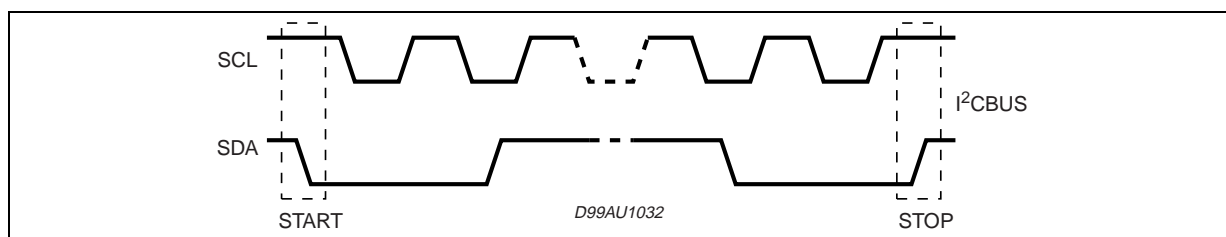

**Figure 24. Acknowledge on the I<sup>2</sup>C BUS**

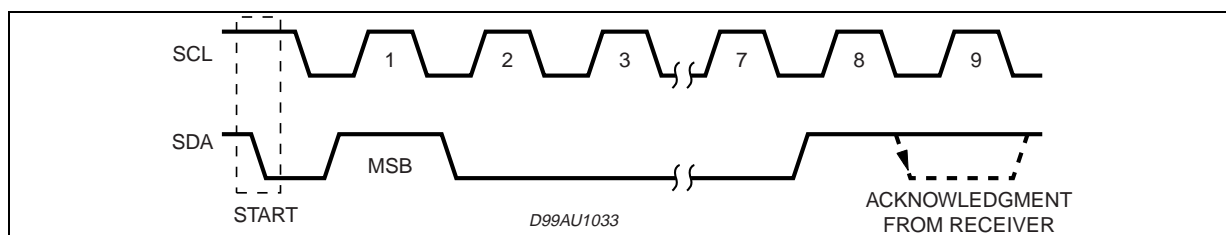

**SOFTWARE SPECIFICATIONS**

All the functions of the TDA7564 are activated by I<sup>2</sup>C interface.

The bit 0 of the "ADDRESS BYTE" defines if the next bytes are write instruction (from  $\mu$ P to TDA7564) or read instruction (from TDA7564 to  $\mu$ P).

Chip Address:

<b>D7</b>	1	1	0	1	1	0	0	<b>D0</b>	X	D8 Hex
-----------	---	---	---	---	---	---	---	-----------	---	--------

X = 0 Write to device

X = 1 Read from device

If R/W = 0, the  $\mu$ P sends 2 "Instruction Bytes": IB1 and IB2.

**IB1**

<b>D7</b>	X
<b>D6</b>	Diagnostic enable (D6 = 1) Diagnostic defeat (D6 = 0)
<b>D5</b>	Offset Detection enable (D5 = 1) Offset Detection defeat (D5 = 0)
<b>D4</b>	Front Channel Gain = 26dB (D4 = 0) Gain = 12dB (D4 = 1)
<b>D3</b>	Rear Channel Gain = 26dB (D3 = 0) Gain = 12dB (D3 = 1)
<b>D2</b>	Mute front channels (D2 = 0) Unmute front channels (D2 = 1)
<b>D1</b>	Mute rear channels (D1 = 0) Unmute rear channels (D1 = 1)
<b>D0</b>	Clip detector 2% (D0 = 0) Clip detector 10% (D0 = 1)

**IB2**

<b>D7</b>	X
<b>D6</b>	used for testing
<b>D5</b>	used for testing
<b>D4</b>	Stand-by on - Amplifier not working - (D4 = 0) Stand-by off - Amplifier working - (D4 = 1)
<b>D3</b>	Power amplifier mode diagnostic (D3 = 0) Line driver mode diagnostic (D3 = 1)
<b>D2</b>	Current detection diagnostic enabled (D2 = 1) Current detection diagnostic defeat (D2 = 0)
<b>D1</b>	Right Channels Power amplifier working in standard mode (D1 = 0) Power amplifier working in high efficiency mode (D1 = 1)
<b>D0</b>	Left Channels Power amplifier working in standard mode (D0 = 0) Power amplifier working in high efficiency mode (D0 = 1)

## TDA7564

If R/W = 1, the TDA7564 sends 4 "Diagnostics Bytes" to  $\mu$ P: DB1, DB2, DB3 and DB4.

### DB1

<b>D7</b>	Thermal warning active (D7 = 1)
<b>D6</b>	Diag. cycle not activated or not terminated (D6 = 0) Diag. cycle terminated (D6 = 1)
<b>D5</b>	Channel LF current detection Output peak current < 250mA - Open load (D5 = 1) Output peak current > 500mA - Open load (D5 = 0)
<b>D4</b>	Channel LF Turn-on diagnostic (D4 = 0) Permanent diagnostic (D4 = 1)
<b>D3</b>	Channel LF Normal load (D3 = 0) Short load (D3 = 1)
<b>D2</b>	Channel LF Turn-on diag.: No open load (D2 = 0) Open load detection (D2 = 1) Offset diag.: No output offset (D2 = 0) Output offset detection (D2 = 1)
<b>D1</b>	Channel LF No short to Vcc (D1 = 0) Short to Vcc (D1 = 1)
<b>D0</b>	Channel LF No short to GND (D1 = 0) Short to GND (D1 = 1)

### DB2

<b>D7</b>	Offset detection not activated (D7 = 0) Offset detection activated (D7 = 1)
<b>D6</b>	Current sensor not activated (D6 = 0) Current sensor activated (D6 = 1)
<b>D5</b>	Channel LR current detection Output peak current < 250mA - Open load (D5 = 1) Output peak current > 500mA - Open load (D5 = 0)
<b>D4</b>	Channel LR Turn-on diagnostic (D4 = 0) Permanent diagnostic (D4 = 1)
<b>D3</b>	Channel LR Normal load (D3 = 0) Short load (D3 = 1)
<b>D2</b>	Channel LR Turn-on diag.: No open load (D2 = 0) Open load detection (D2 = 1) Permanent diag.: No output offset (D2 = 0) Output offset detection (D2 = 1)
<b>D1</b>	Channel LR No short to Vcc (D1 = 0) Short to Vcc (D1 = 1)
<b>D0</b>	Channel LR No short to GND (D1 = 0) Short to GND (D1 = 1)



## DB3

<b>D7</b>	Stand-by status (= IB1 - D4)
<b>D6</b>	Diagnostic status (= IB1 - D6)
<b>D5</b>	Channel RF current detection Output peak current < 250mA - Open load (D5 = 1) Output peak current > 500mA - Open load (D5 = 0)
<b>D4</b>	Channel RF Turn-on diagnostic (D4 = 0) Permanent diagnostic (D4 = 1)
<b>D3</b>	Channel RF Normal load (D3 = 0) Short load (D3 = 1)
<b>D2</b>	Channel RF Turn-on diag.: No open load (D2 = 0) Open load detection (D2 = 1) Permanent diag.: No output offset (D2 = 0) Output offset detection (D2 = 1)
<b>D1</b>	Channel RF No short to Vcc (D1 = 0) Short to Vcc (D1 = 1)
<b>D0</b>	Channel RF No short to GND (D1 = 0) Short to GND (D1 = 1)

## DB4

<b>D7</b>	X
<b>D6</b>	X
<b>D5</b>	Channel RR current detection Output peak current < 250mA - Open load (D5 = 1) Output peak current > 500mA - Open load (D5 = 0)
<b>D4</b>	Channel RR Turn-on diagnostic (D4 = 0) Permanent diagnostic (D4 = 1)
<b>D3</b>	Channel RR Normal load (D3 = 0) Short load (D3 = 1)
<b>D2</b>	Channel RR Turn-on diag.: No open load (D2 = 0) Open load detection (D2 = 1) Permanent diag.: No output offset (D2 = 0) Output offset detection (D2 = 1)
<b>D1</b>	Channel RR No short to Vcc (D1 = 0) Short to Vcc (D1 = 1)
<b>D0</b>	Channel RR No short to GND (D1 = 0) Short to GND (D1 = 1)

**Examples of bytes sequence**

**1 - Turn-On diagnostic - Write operation**

Start	Address byte with D0 = 0	ACK	IB1 with D6 = 1	ACK	IB2	ACK	STOP
-------	--------------------------	-----	-----------------	-----	-----	-----	------

**2 - Turn-On diagnostic - Read operation**

Start	Address byte with D0 = 1	ACK	DB1	ACK	DB2	ACK	DB3	ACK	DB4	ACK	STOP
-------	--------------------------	-----	-----	-----	-----	-----	-----	-----	-----	-----	------

The delay from 1 to 2 can be selected by software, starting from T.B.D. ms

**3a - Turn-On of the power amplifier with 26dB gain, mute on, diagnostic defeat, High eff. mode both channels..**

Start	Address byte with D0 = 0	ACK	IB1	ACK	IB2	ACK	STOP
			X000000X		XXX1X011		

**3b - Turn-Off of the power amplifier**

Start	Address byte with D0 = 0	ACK	IB1	ACK	IB2	ACK	STOP
			X0XXXXXX		XXX0XXXX		

**4 - Offset detection procedure enable**

Start	Address byte with D0 = 0	ACK	IB1	ACK	IB2	ACK	STOP
			XX1XX11X		XXX1X0XX		

**5 - Offset detection procedure stop and reading operation (the results are valid only for the offset detection bits (D2 of the bytes DB1, DB2, DB3, DB4).**

Start	Address byte with D0 = 1	ACK	DB1	ACK	DB2	ACK	DB3	ACK	DB4	ACK	STOP
-------	--------------------------	-----	-----	-----	-----	-----	-----	-----	-----	-----	------

- The purpose of this test is to check if a D.C. offset (2V typ.) is present on the outputs, produced by input capacitor with anomalous leakage current or humidity between pins.
- The delay from 4 to 5 can be selected by software, starting from T.B.D. ms

**6 - Current detection procedure start (the AC inputs must be with a proper signal that depends on the type of load)**

Start	Address byte with D0 = 0	ACK	IB1	ACK	IB2	ACK	STOP
			XX01111X		XXX1X1XX		

**7 - Current detection reading operation (the results valid only for the current sensor detection bits - D5 of the bytes DB1, DB2, DB3, DB4).**

Start	Address byte with D0 = 1	ACK	DB1	ACK	DB2	ACK	DB3	ACK	DB4	ACK	STOP
-------	--------------------------	-----	-----	-----	-----	-----	-----	-----	-----	-----	------

- During the test, a sinus wave with a proper amplitude and frequency (depending on the loudspeaker under test) must be present. The minimum number of periods that are needed to detect a normal load is 5.
- The delay from 6 to 7 can be selected by software, starting from T.B.D. ms.

DIM.	mm			inch		
	MIN.	TYP.	MAX.	MIN.	TYP.	MAX.
A	4.45	4.50	4.65	0.175	0.177	0.183
B	1.80	1.90	2.00	0.070	0.074	0.079
C		1.40			0.055	
D	0.75	0.90	1.05	0.029	0.035	0.041
E	0.37	0.39	0.42	0.014	0.015	0.016
F (1)			0.57			0.022
G	0.80	1.00	1.20	0.031	0.040	0.047
G1	23.75	24.00	24.25	0.935	0.945	0.955
H (2)	28.90	29.23	29.30	1.139	1.150	1.153
H1		17.00			0.669	
H2		12.80			0.503	
H3		0.80			0.031	
L (2)	22.07	22.47	22.87	0.869	0.884	0.904
L1	18.57	18.97	19.37	0.731	0.747	0.762
L2 (2)	15.50	15.70	15.90	0.610	0.618	0.626
L3	7.70	7.85	7.95	0.303	0.309	0.313
L4		5			0.197	
L5		3.5			0.138	
M	3.70	4.00	4.30	0.145	0.157	0.169
M1	3.60	4.00	4.40	0.142	0.157	0.173
N		2.20			0.086	
O		2			0.079	
R		1.70			0.067	
R1		0.5			0.02	
R2		0.3			0.12	
R3		1.25			0.049	
R4		0.50			0.019	
V			5° (T p.)			
V1			3° (Typ.)			
V2			20° (Typ.)			
V3			45° (Typ.)			

(1): dam-bar protusion not included  
 (2): molding protusion included

**OUTLINE AND MECHANICAL DATA**

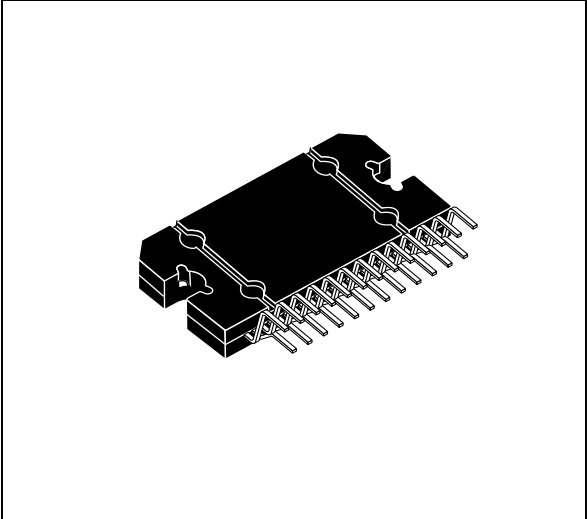

**Flexiwatt25 (vertical)**

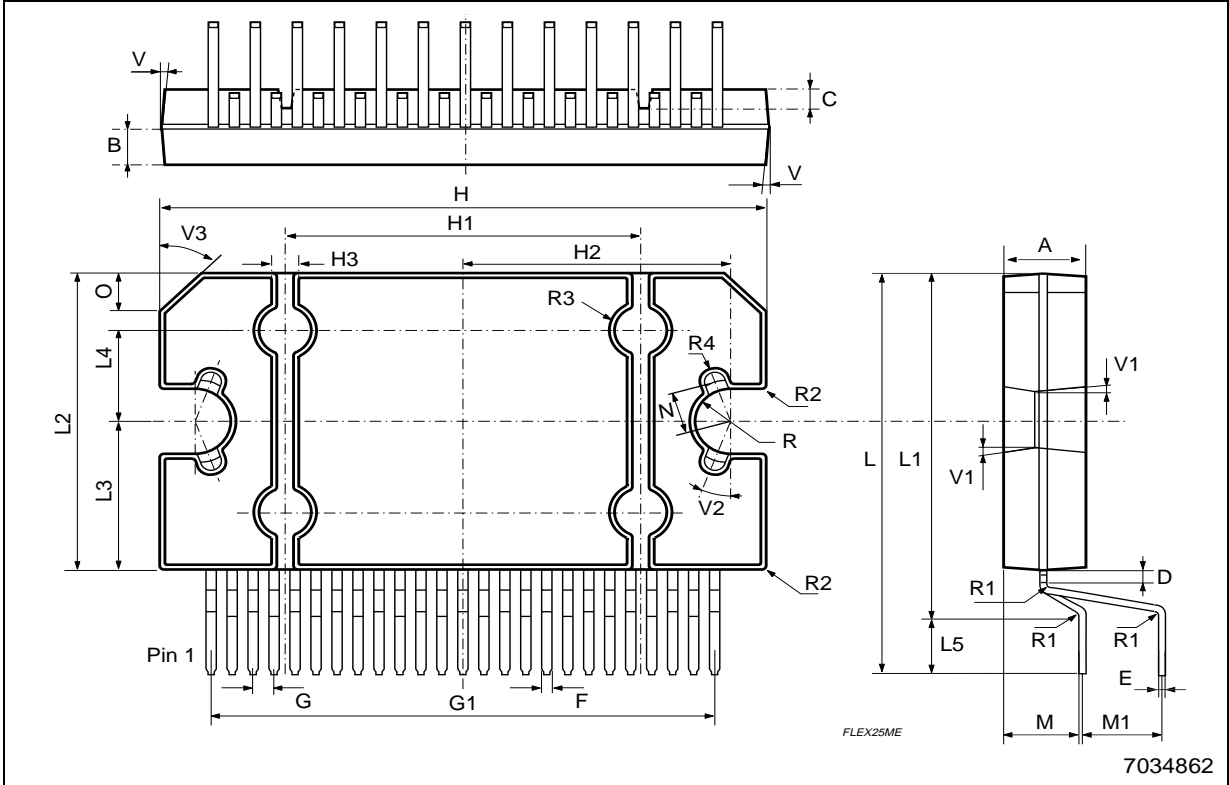

Information furnished is believed to be accurate and reliable. However, STMicroelectronics assumes no responsibility for the consequences of use of such information nor for any infringement of patents or other rights of third parties which may result from its use. No license is granted by implication or otherwise under any patent or patent rights of STMicroelectronics. Specifications mentioned in this publication are subject to change without notice. This publication supersedes and replaces all information previously supplied. STMicroelectronics products are not authorized for use as critical components in life support devices or systems without express written approval of STMicroelectronics.

The ST logo is a registered trademark of STMicroelectronics.  
All other names are the property of their respective owners

© 2003 STMicroelectronics - All rights reserved

**STMicroelectronics GROUP OF COMPANIES**

Australia - Belgium - Brazil - Canada - China - Czech Republic - Finland - France - Germany - Hong Kong - India - Israel - Italy - Japan -  
Malaysia - Malta - Morocco - Singapore - Spain - Sweden - Switzerland - United Kingdom - United States  
[www.st.com](http://www.st.com)